

The KRONNER SIDE-KICK

A uterine manipulator holder

for holding the

KRONNER VAGINAL CUFF MANIPULATOR (VCM)

Instructions for use

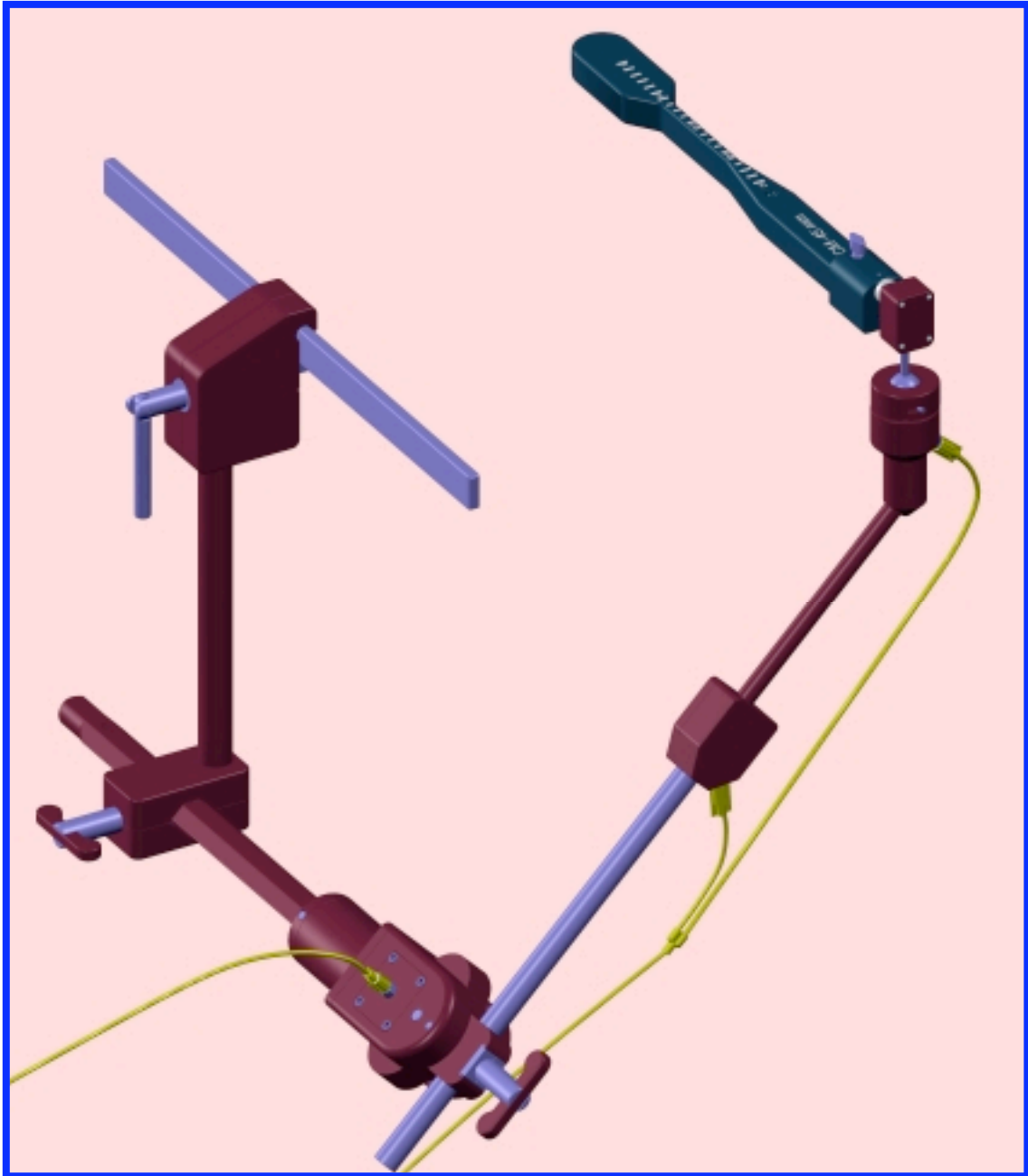

United States Patent 8,485,484.B2

The KRONNER SIDE-KICK

A uterine manipulator Holder
which holds the Kronner Vaginal Cuff Manipulator

Richard F. Kronner MD FACS

The **Kronner SIDE-KICK** which is a **uterine manipulator Holder** firmly holds the Kronner Vaginal Cuff Manipulator (VCM) during laparoscopic surgery on female pelvic organs, thereby freeing a person for performing other tasks.

The Side-Kick is attached to either operating table rail behind the leg stirrup attachment.

The VCM* is inserted into the patient using standard technique, then the Side-Kick is joined to it through an adapter.

With proper adapters the Side-Kick may be used with various other manipulators, such as the RUMI, the VCare, Advincula, the Arch Koh, and the Kronner Vaginal Retractor.

A gas supply module, which can be attached to the operating table rail,

transfers nitrogen or compressed air from the hospital wall or a portable tank to the Side-Kick through two flexible lines. When the module switch is turned on, the Sidekick joints lock. When the switch is turned off the Side-Kick joints are decompressed.

Pressing a foot pedal, which is connected to the gas supply module, releases all the Side-Kick joints for position changes. When the foot pedal is released the joints lock.

A branched gas line connects the supply module to two luers of the arm assembly. A single gas line joins the gas supply module to the main pivot.

Only the arm components, VCM's, and adapters are steam sterilized.

The disposable gas lines are supplied sterile.

Intended use:

The Kronner Side-Kick Uterine/vaginal Manipulator Holder is intended to assist the surgical staff in mounting, positioning and holding a uterine manipulator during gynecological laparoscopic surgical procedures. It is intended for use by trained operating room personnel in an operating room environment.

"Caution: Federal law restricts this device to sale by or on the order of a physician."

COMPONENTS

Sidekick with vaginal cuff manipulator

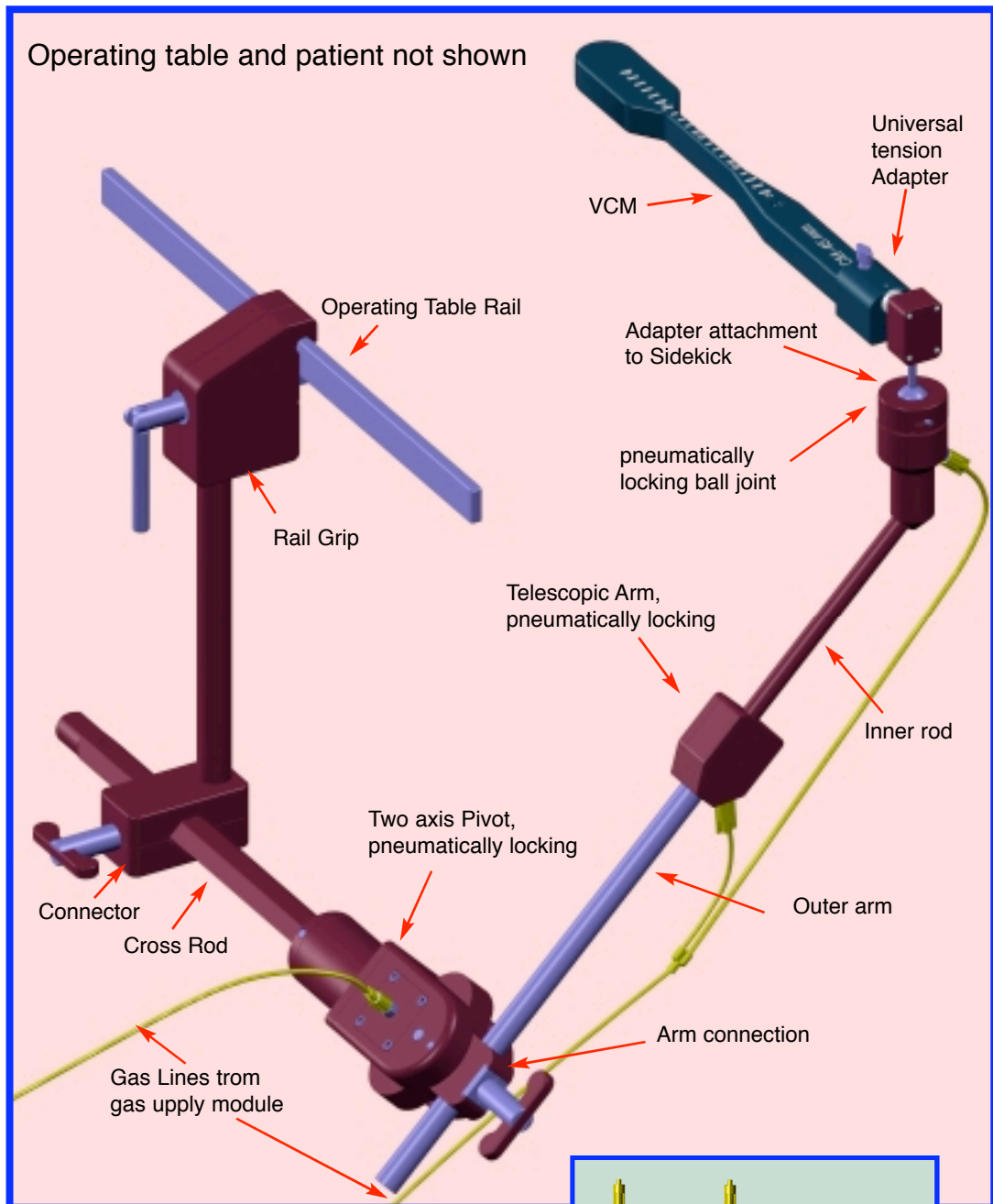

High Pressure GAS LINES

supplied sterile,
shelf life 3 years,
see package label

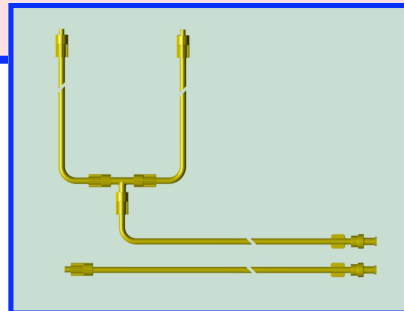

GAS SUPPLY MODULE

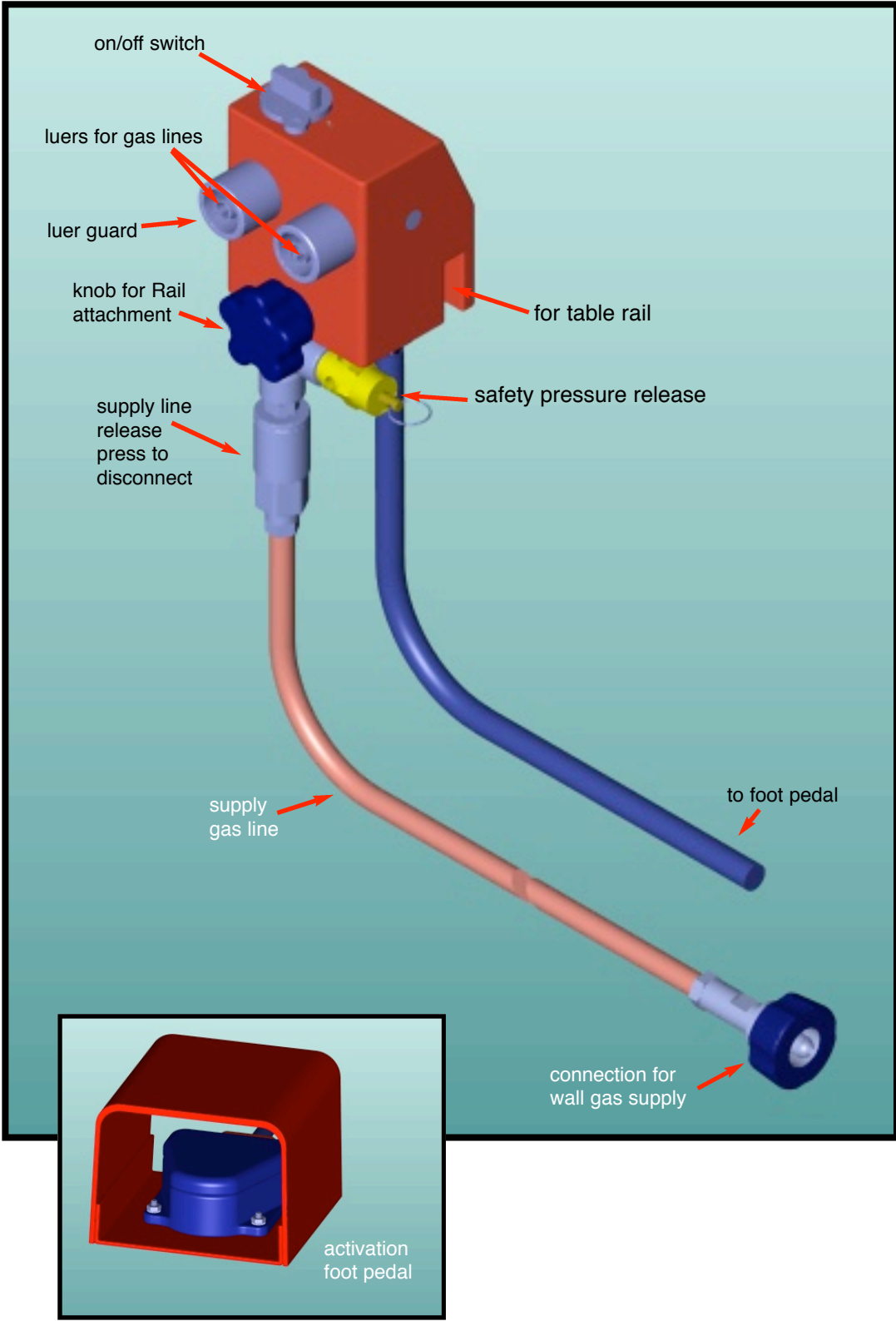

Kronner Vaginal Cuff Manipulators Insert Widths 40, 45, 50 mm

Connects to the Sidekick uterine manipulator holder
through an adapter or is hand held

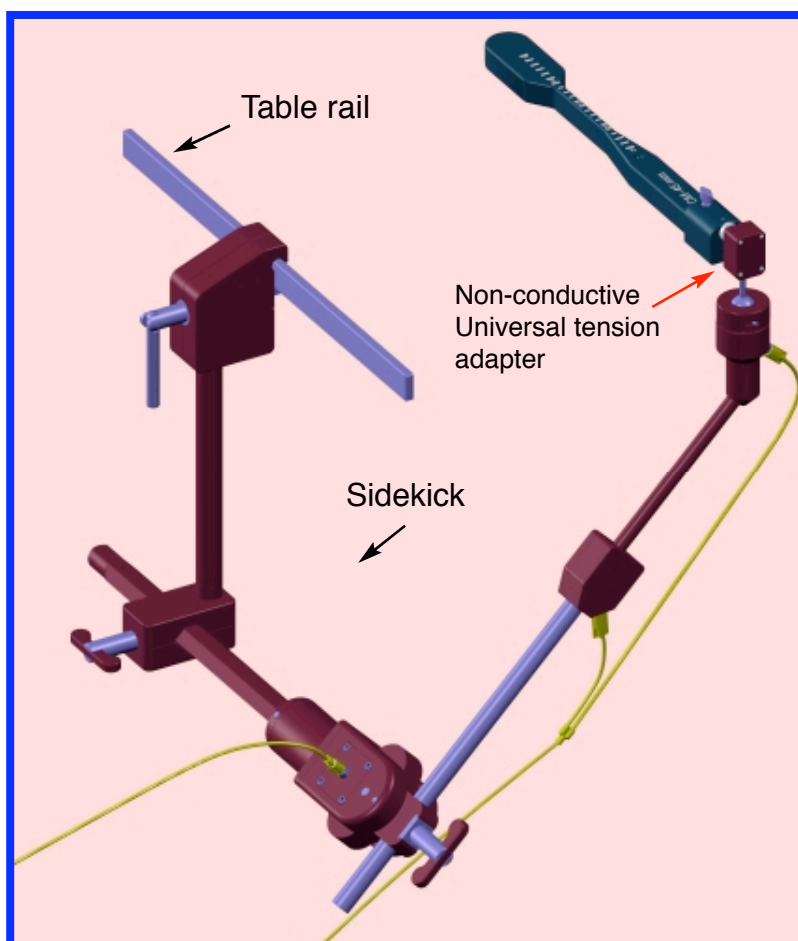
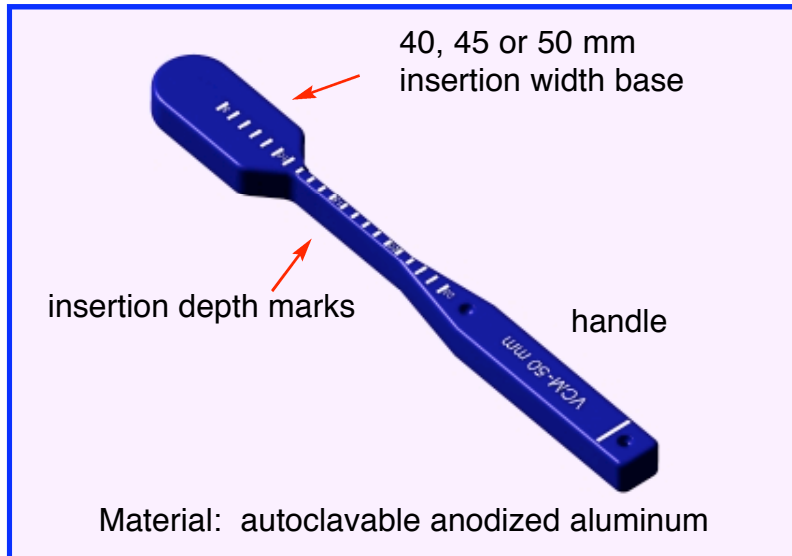

Using the Kronner VCM With the Universal Adapter attached to the Sidekick

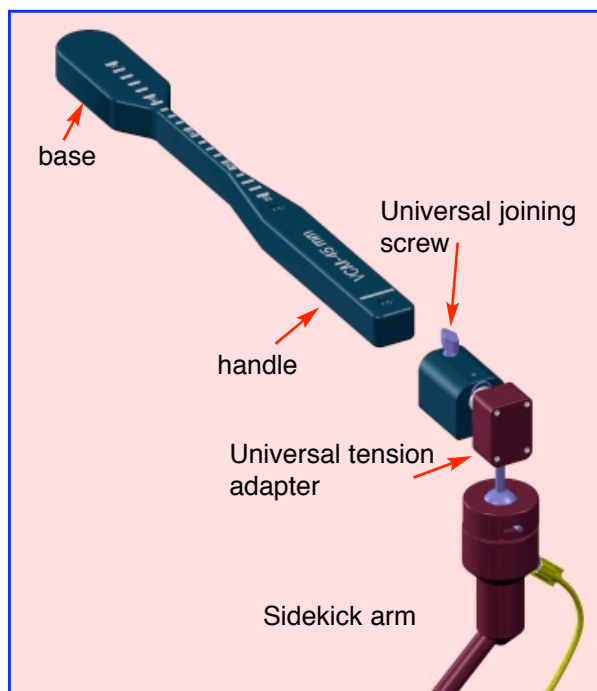

1. Select the VCM with the base insertion width of 40, 45, or 50 mm.
2. Loosen the joining screw on the universal tension adapter.
3. Support the the Sidekick arm and insert the VCM into the adapter.
4. Tighten the joining screw.

For VCare users, the VCM connects to the Kronner SideKick through the VCM / VCare Connector and VCare tension adapter.

The Kronner VCM / VCare radel connector fits between the VCare tension adapter and the Kronner VCM so the VCM can be held by Sidekick for vaginal surgery when the only adapter available is for holding the VCare® manipulator.

This procedure usually follows a laparoscopic hysterectomy aided by the Vcare® uterine manipulator.

The connector is non-conductive, preventing the VCM from any possible grounding and thus protecting the VCM from causing a patient injury from electrocautery.

The VCare tension adapter allows the VCM to be rotated 360 degrees around its long axis. Sidekick allows for unrestricted other positioning.

**Using the Kronner VCM with the VCM / VCare Radel Connector
attached to the VCare Tension Adapter**
following the use of the VCare® uterine manipulator

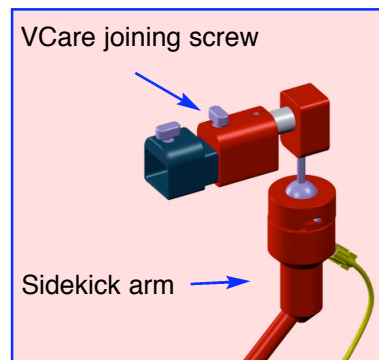
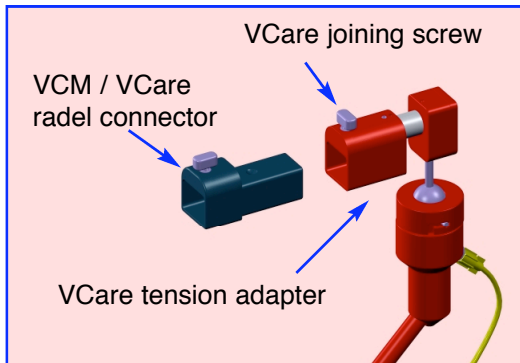
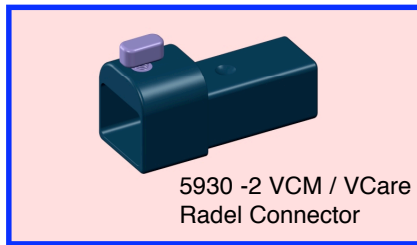

1. Loosen the VCare joining screw.
2. Support the the Sidekick arm.
Insert the radel connector into the VCare tension adapter.
3. Tighten the VCare joining screw.
4. Select the VCM with the base insertion width of 40, 45, or 50 mm.
5. Insert the VCM into the patient.
6. Support the Sidekick arm, step on the foot pedal and slide the attached VCM / VCare radel connector over the VCM.
7. Tighten the Radel connector screw

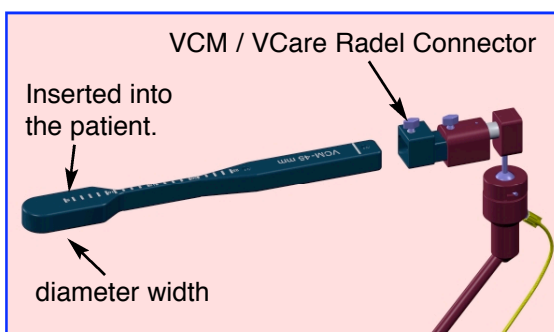

VCM hand held or attached to Sidekick

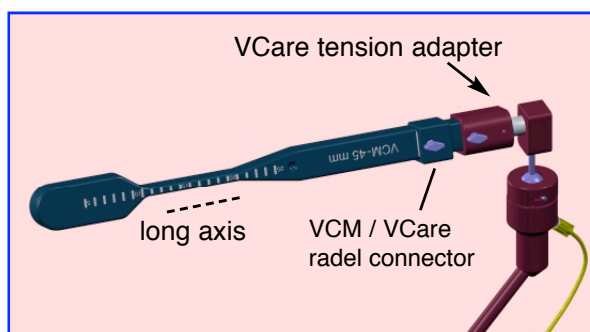

8. The attached VCM can be rotated 360 degrees without stepping on the foot pedal.

Indications for use:

The Kronner Side-Kick Uterine Manipulator Holder is intended for use by trained operating room personnel in an operating room environment.

Contraindications:

1. Table rail unreliable
2. Gas supply is unreliable or unavailable at required pressure

Warnings:

1. Do not use with pressure greater than 150 psi.
2. Do not detach the gas supply module from the gas supply while the VCM is attached.
3. Do not shut off the gas supply module switch while the VCM is attached.
4. Do not use substitute flexible gas lines.
5. Do not use if gas leaks are detected.
6. On older operating tables with motorized perineal rests make sure the rest is in the down position before adding the main pivot and the remainder of the assembly.
7. The gas module switch must be in the "on" position during use
8. Do not use the sterile lines if the package is damaged or the 3 year expiration date is passed.
9. Do not attach the Holder to a VCM inserted into a patient that is not under anesthesia or otherwise immobilized.
10. Use only nitrogen or compressed air gas.
11. In the event the Side-Kick was disassembled without turning off the gas module switch, the pneumatic joints may still be pressurized. To decompress, attach a male luer from a branched gas line with one short branch disconnected, or use a syringe with the plunger removed.
12. Do not attach the Sidekick rail grip over an attachment of the table rail to the table.
13. Attach the single gas line to the pivot and the branched line to the arm.
- 14. Remove the Sidekick arm before raising the lower end of the operating table.**
- 15. Support the Arm when releasing Sidekick gas pressure.**
- 16. Do not connect the VCM to a non-insulated holder.**

Precautions:

1. Verify that the operating table rail is not loose.
2. Verify that the operating table end can be lowered or removed.
3. Restrain the patient from sliding on the table when the table is tilted.
4. Prevent the gas supply line from damage due to moving objects.
5. Check the VCM for proper placement.
6. Verify that the gas supply is steady and available at 140-150 psi.
7. Securely attach all flexible gas lines to the gas supply module and to the holder.
8. Read the instruction manual prior to use.
9. When making a patient transfer to or from the operating table to a cart with Sidekick in between remove Sidekick or protect it from the cart.
10. Always support a connected VCM (vaginal cuff manipulator) when stepping on the gas pedal.

HIGH PRESSURE GAS LINES

supplied sterile
shelf life three years

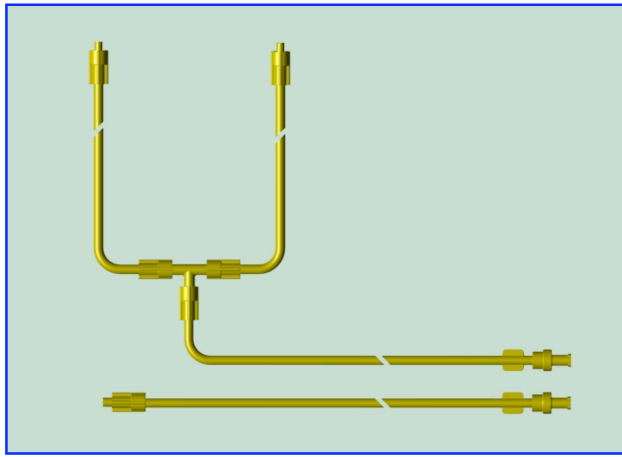

STERILIZABLE COMPONENTS

Outer arm, Inner rod, VCM,
Black Universal Tension adapter, screws
and / or VCare Tension adapter, VCM / Vcare radel connector

Joining the inner rod to the arm.

1. After sterilization, insert the inner rod into the outer arm.
2. If resistance is met, gas pressure may not have been released from the luer of the outer arm after the last use.

To remove the gas, attach a male luer from a branched gas line with one short branch disconnected, or use a syringe with the plunger removed.

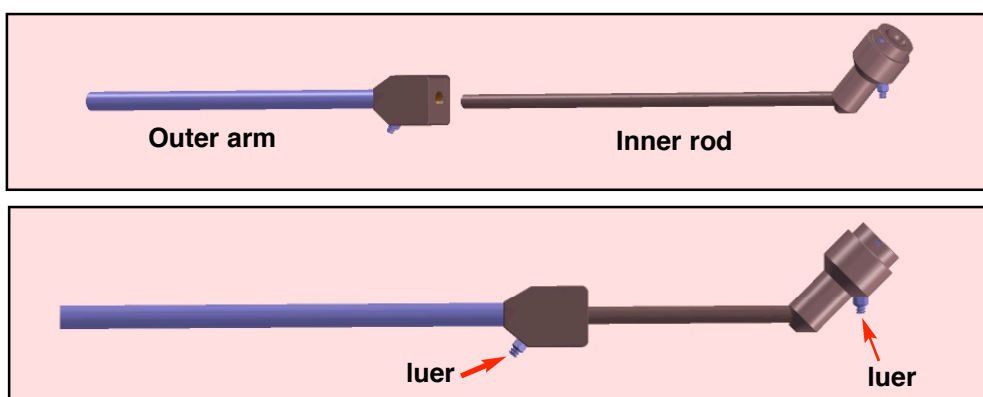

NON-STERILIZABLE COMPONENTS

Gas supply module, foot pedal assembly, main pivot, rail grip

Setting up the Gas Supply Module

1. Attach the gas supply module to the operating table rail at a position where the flexible gas lines will reach to the Holder gas line connections. Usually this is just beside the planned position for the Holder rail grip.

Whenever possible attach the gas module to the side of the table not used for patient transfer.

2. Turn off the module switch. This will prevent gas from leaking from the luer connections prior to flexible gas line connection.

3. Connect the gas line to the hospital nitrogen* or compressed air supply.

4. Set the supply to 130-150 PSI.

5. Position the attached foot pedal.
(Note that it cannot be disconnected from the supply module.)

*not nitrous oxide

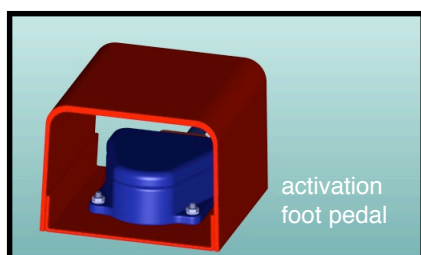
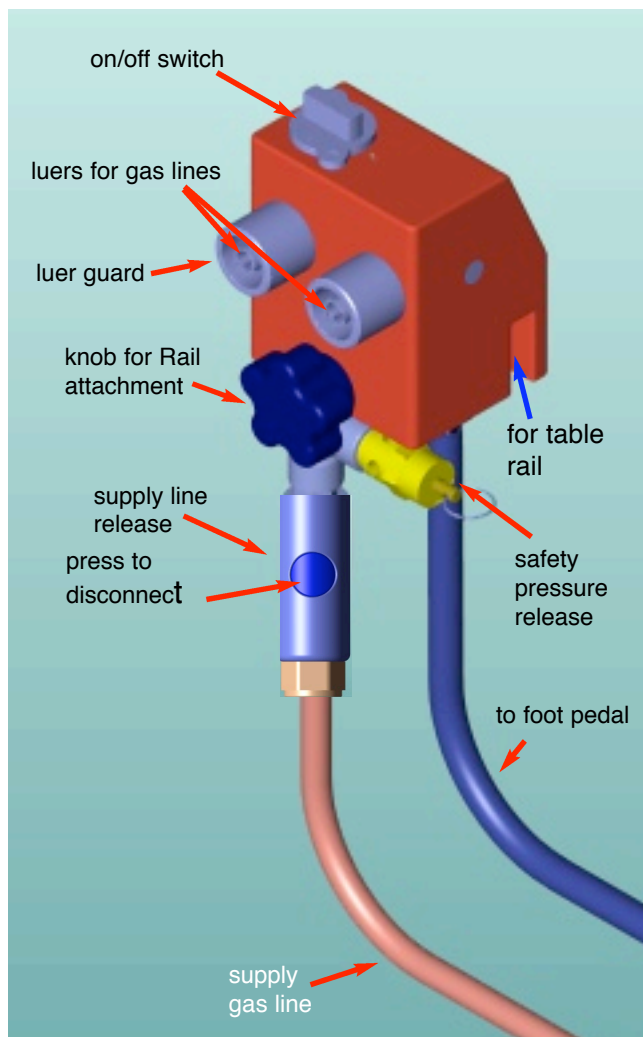

Attaching the Rail Grip assembly to the operating table rail

The rail grip assembly can be placed on either rail behind the attachment for the leg stirrup.

1. Rotate the rail grip handle counter-clockwise until the bottom of the lower rail grip aligns with the index mark.

This setting will allow the rail grip assembly to be attached by tilting it outward.

In order to attach it without tilting, more counter-clockwise rotations are required.

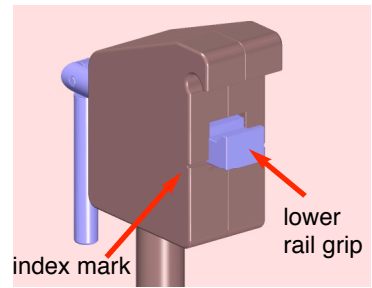

2. Select a position, on the rail, that will place the Holder arm directly below the manipulator.*

3. Tilt the assembly outward and set it on the rail. Pivot it toward the rail until the lower rail grip is below the rail.

Corrections can be made later by repositioning the main pivot assembly.*

The rail grip can be released and slid on the rail to re-position if necessary.*

*The design of the Holder allows for variability in these settings.

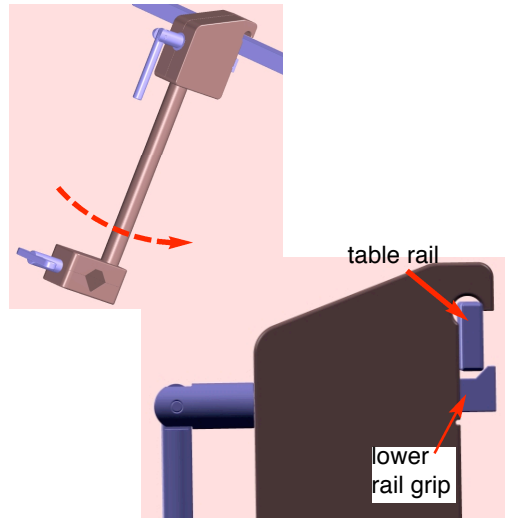

4. Rotate the handle clockwise until it is tight, approximately three full rotations.

Be sure the assembly is hanging straight downward in both planes during this step and the rail grip upper notch is touching the rail on both sides of the rail grip.

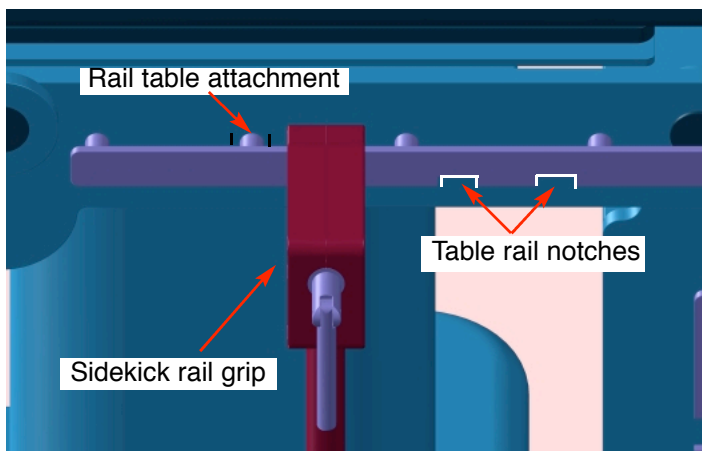
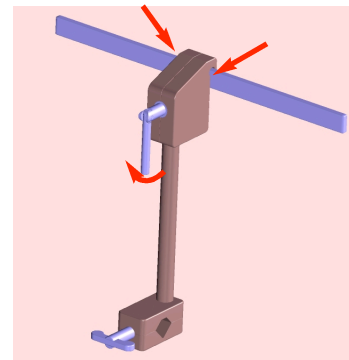

When placing the Sidekick Rail Grip onto the table rail, do not put it over the rail table attachment or a table rail notch.

Placing it in these areas could cause an unstable attachment.

Attaching the main pivot assembly to the connector of the rail grip assembly

1. Rotate the T-handle counter-clockwise to a stop to open the connection joint for the main pivot cross rod.

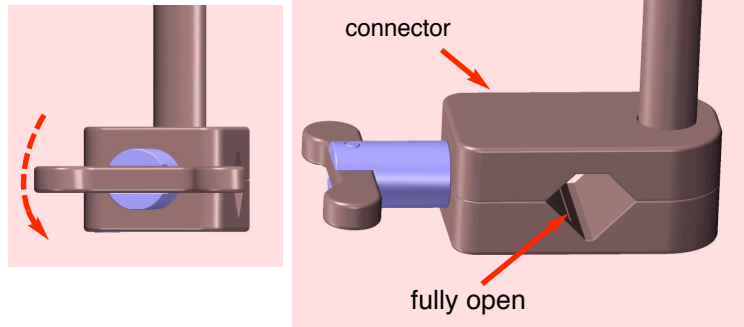

2. Position the main pivot and cross rod so "UP" is positioned upward.

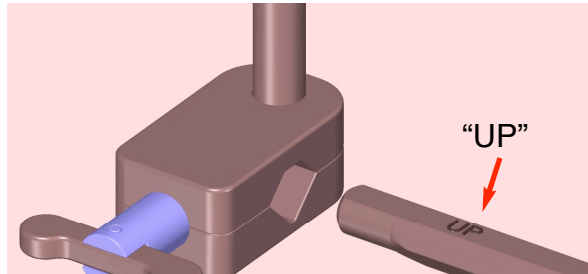

3. Insert the cross rod into the connection joint.

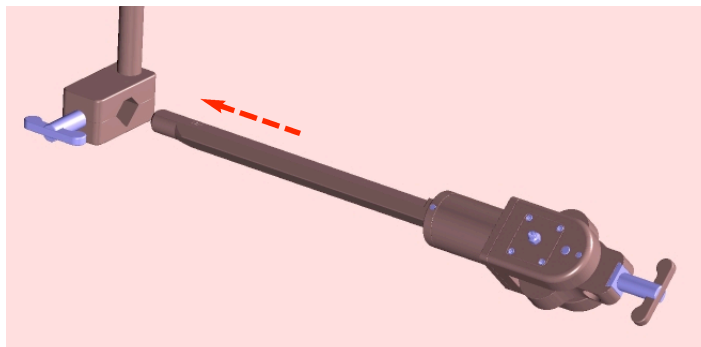

4. Slide the main pivot until the arm connection is located below the planned connection to the manipulator.

5. Firmly tighten the T-handle clockwise.

This setting can be changed later, if needed.

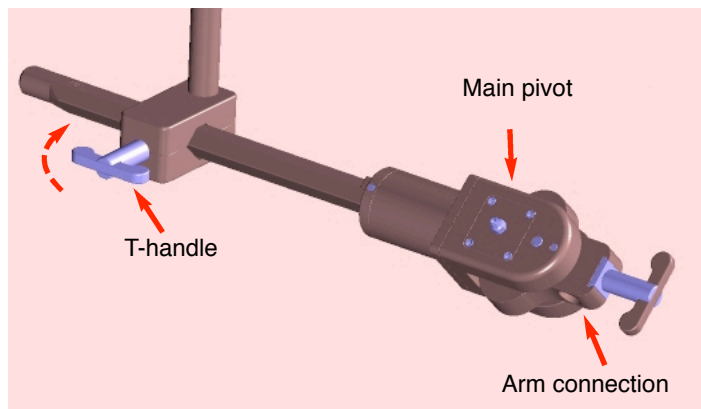

Attaching the arm to the main pivot.

1. Rotate the main pivot handle counter-clockwise to a stop to open the attachment joint.

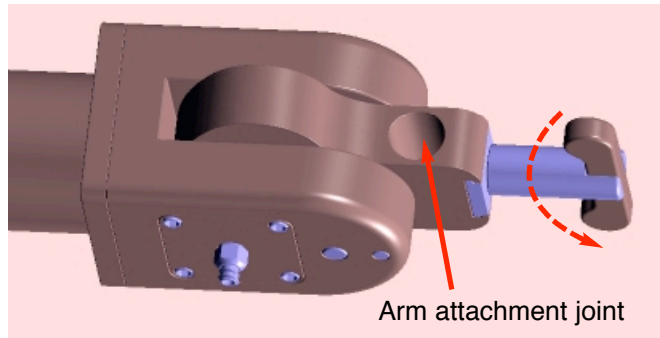

2. Insert the arm assembly into the attachment joint until the telescoping rod will allow for the required manipulator movement.

This setting can be changed later, if necessary.

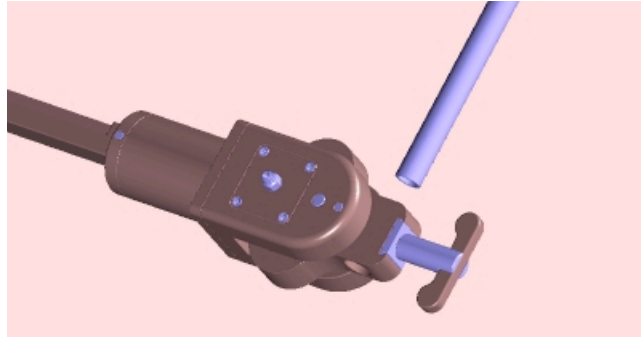

3. Tighten the main pivot handle clockwise.

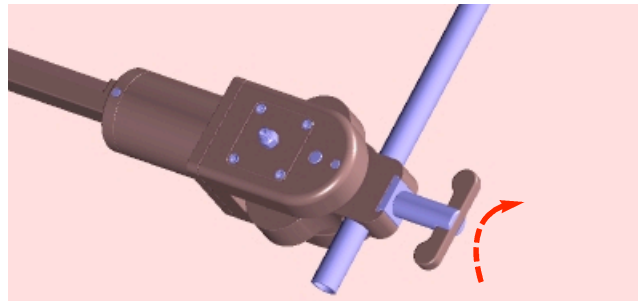

Stops prevent the arm from falling prior to pressurizing the system. Do NOT overcome these stops.

4. Lower the arm sideways to one of the stops or continue to hold it during the next steps.

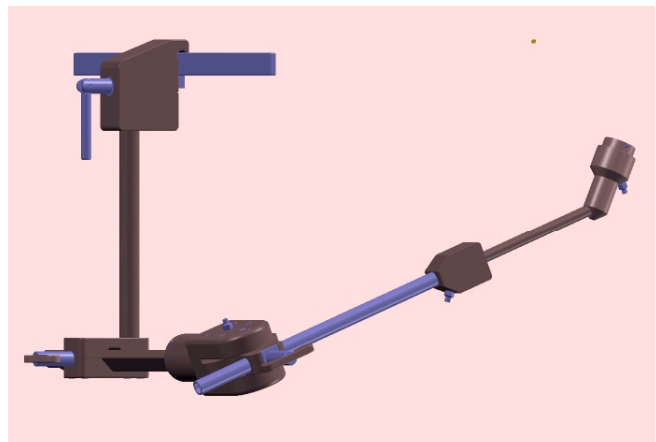

Attaching the gas lines

Warning: Do not attach a gas line to a uterine manipulator, extreme danger.

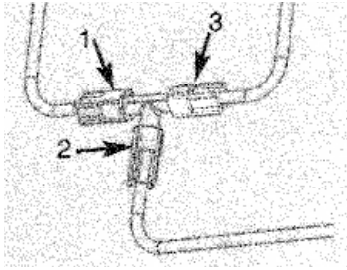

1. Check these three gas line luer connections and firmly tighten if loose.

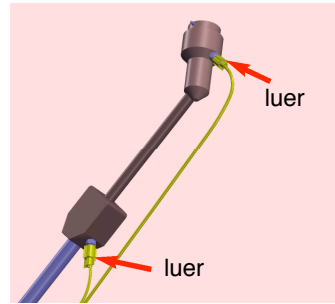

4. Connect the branched line to the two luers of the arm assembly.

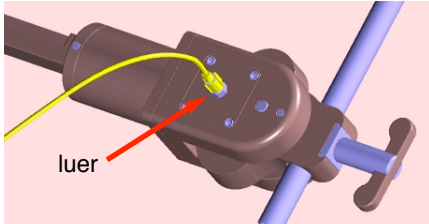

2. Connect the single gas line to the main pivot luer.

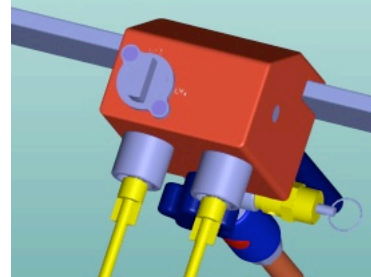

5. Connect the other end to the remaining luer of the supply module.

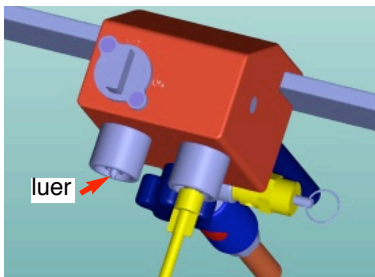

3. Connect the other end of the single gas line to one of the gas output luers of the supply module.

Note: The gas line connections to the arm may be made prior to joining the arm to the main pivot assembly.

The single gas line may be connected to the pivot and the supply module prior to arm attachment.

To avoid confusion, make these connections prior to inserting the manipulator into the patient.

Turning the gas on

Position the arm and Turn the gas on by turning the supply module switch to "ON"

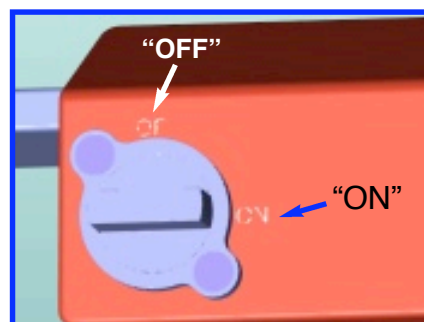

VCM Cleaning Instructions

Manual Cleaning:

1. Detach the Universal or VCare Tension adapter from the Sidekick arm.
2. Remove the joining screw from the chosen adapter and the connector screw from the Radel Connector.
3. Remove the Vaginal Cuff Manipulator, Connector, chosen Adapter, inner rod and outer arm.
4. Use **Enzol® enzymatic detergent**, and prepare according to the manufacture's recommendations of 1 oz. per gallon of warm tap water. (or use an FDA approved equivalent)
5. **Soak all the parts** for five minutes in the prepared solution.
6. **Maneuver parts to loosen trapped soil. Use a soft bristled brush (M16) to gently scrub** to remove any visible soil..
7. **Repeat step 5 two additional times for a total of three times.**
8. **Prepare a tap water bath at 38-49° C.**
9. **Agitate the components by hand** for a minimum of one minute in the prepared bath.
10. **Rinse the components** under running tap water for at least one minute.
11. **Dry the components** with a clean, lint free cloth.

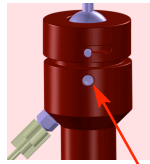

Do not remove this screw

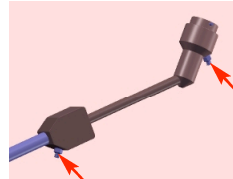

Do not inject liquids into the arm luers.

Sterilizing the components

The rail grip, main pivot assembly, gas supply module with foot pedal are not sterilized nor immersed in any liquids.

1. Place inner rod, outer arm, adapters connector and screws in a Sterilizer tray.
2. Sterilization wrap : Kingard KC400
3. Pre-vacuum temperature: 270 F (132C)
4. Exposure time: 4.0 minutes
5. Drying time: 45 minutes

How to order:

1. 5675 Universal tension adapter with joining screw **or** 5920-2 VCare Tension Adapter
 2. 1752-2 Adapter & Connector Joining screw
 3. VCM-40 Vaginal Cuff Manipulator 40 mm*
 4. VCM-45 Vaginal Cuff Manipulator 45 mm
 5. VCM-50 Vaginal Cuff Manipulator 50 mm
 6. 5930-2 VCM / VCare Radel Connector
 7. KSK-5000 Kronner Sidekick
- * blade width

Kronner Medical

1443 Upper Cleveland Rapids Road
Roseburg, Oregon 97471

Phone: (800) 706-3533 or (541) 672-2543
Fax: (541) 672-1074 Web: www.kronner.com
E-mail: kronner@rosenet.net